

Biogeochemistry of the Scheldt Estuary and Plume



M. Shimoni & M. Acheroy

Signal and Image Centre, Royal Military Academy;



D. Sirjacobs & S. Djenidi

GeoHydrodynamic and Environmental Research department, Liege University;



A. V. Borges & M. Frankignoulle

Chemical Oceanography Unit, Liege University;



L. Chou



**Chemical Oceanography and Water Geochemistry department, Free University
Brussels;**



W. Yvermans

Laboratory of Protistology and Aquatic Ecology, University of Gent.

- ▣ **Location, Objective and Interest**
- ▣ **Airborne campaign**
- ▣ **In-situ campaign**
- ▣ **Image preparation**
- ▣ **Atmospheric correction**
- ▣ **Multiple regression**
- ▣ **Improvements by across track filtering**
- ▣ **Correlation with first derivative spectrum**
- ▣ **Summary**

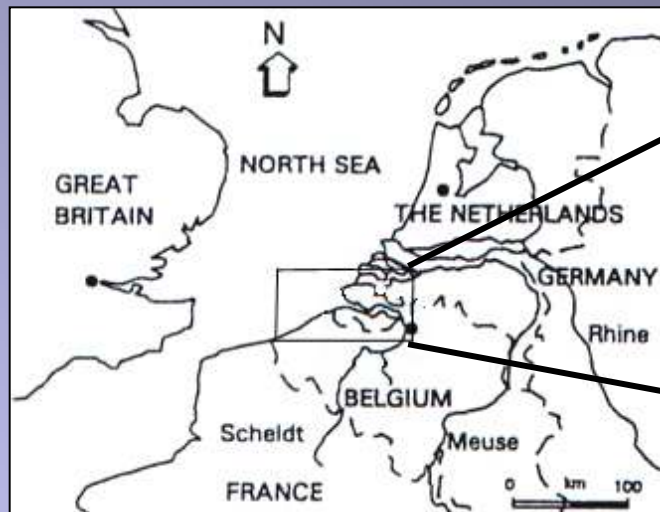

Objective:

Explore the possibility of using CASI-SWIR airborne hyperspectroscopy to retrieve parameters of interest for biogeochemical studies of the Scheldt Estuary and Plume (i.e. phytoplankton pigments, particulate organic matter, colour dissolved organic matter and mineral suspended matter) for case-II ecosystems studies .

Interest:

Develop an approach that may provide high resolution synoptic view of particular parameters to complete the in situ metabolic data sets (ground truth obtained from cruises), possibly increasing thus seasonal coverage.

SEPTEMBER 2002

**The airborne
campaign**

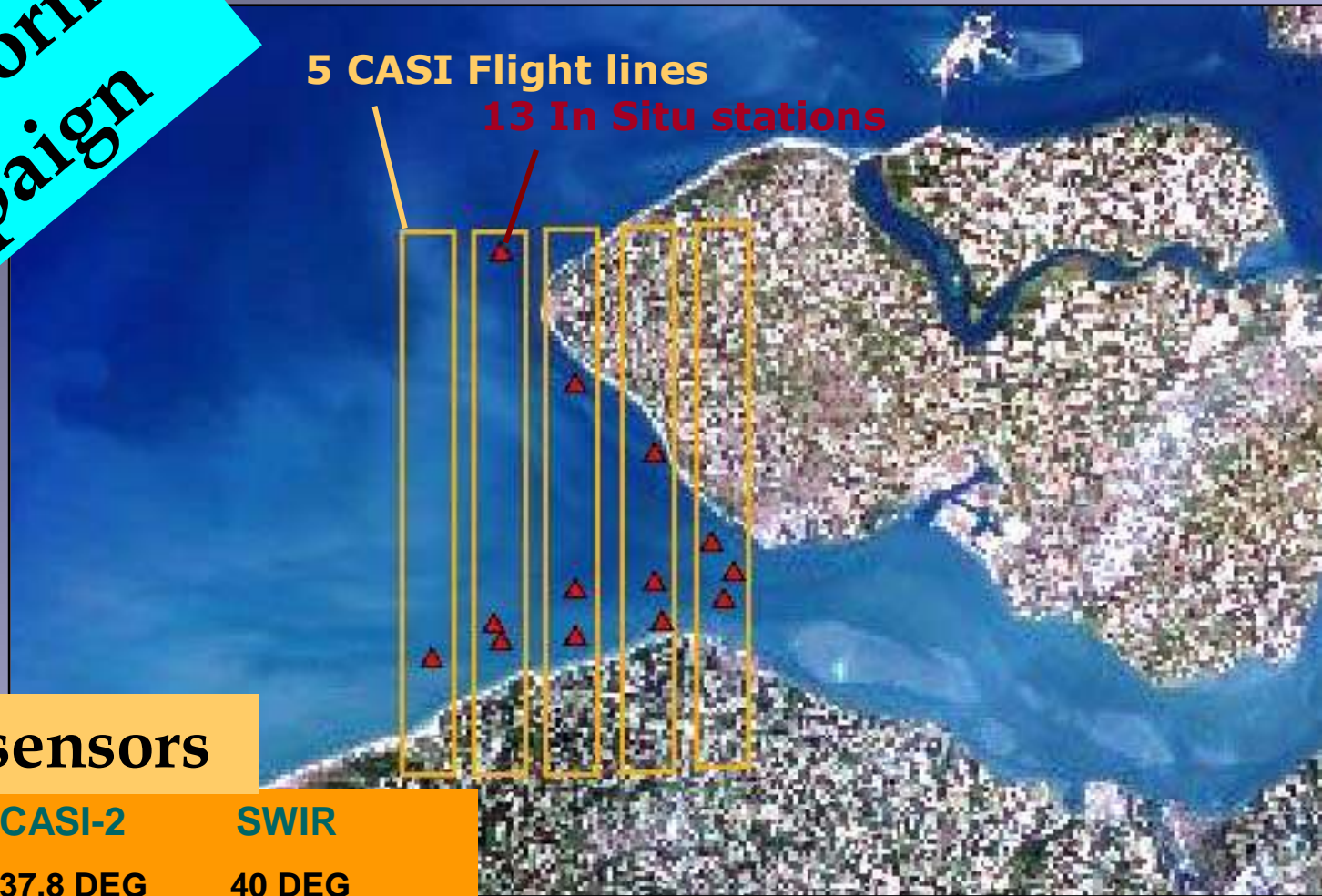

5 CASI Flight lines

13 In Situ stations

Airborne sensors

	CASI-2	SWIR
Field of view (FOV)	37.8 DEG	40 DEG
IFOV	1.3 mRAD	1.1 mRAD
Spatial resolution	4 m	4 m
Spectral range	431-969 nm	850-2500 nm
Spectral channel	48	180

Problems: Spectral bands not set as required

SWIR affected by calibration problems

In-situ campaign

Spectrometry (ASD)

1) **Field spectrometry records** of water leaving radiance;

2) **Laboratory reflection and absorption spectrum** measurements on collected water samples and on some “isolated” optically active components:

- * total suspended matter,
- * colour dissolved organic matter (CDOM),
- * identification of main phytoplankton species

Biochemical parameters

Salinity	chlorophyll <i>a</i>	Dissolved inorganic carbon (DIC)	particulate organic carbon (POC)
Temperature	phaeopigment	Dissolved organic carbon (DOC)	particulate inorganic carbon (PIC)
pH	Total alkalinity	Mineral suspended matter	particulate nitrogen (PN)
pCO ₂	Dissolved O ₂	nutrients (NH ₄ , NO ₃ /NO ₂ , PO ₄ , Si)	Pigments by HPLC
coloured humic substance (CDOM)			
Identification of phytoplankton species			

Image Processing

Basic Processing

Radiometrical, Geometrical and Atmospheric corrections.

Gain and offset corrections using « Effort »

Filtering

Cross track correction

Other processing

Extraction of spectra corresponding to ground truth stations

Research of correlations between spectral and in-situ data

Algorithms

Image processing

Final map of parameter of interest

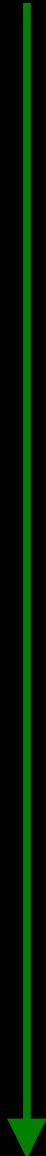

Correlation between in-situ and airborne reflectance following different atmospheric correction

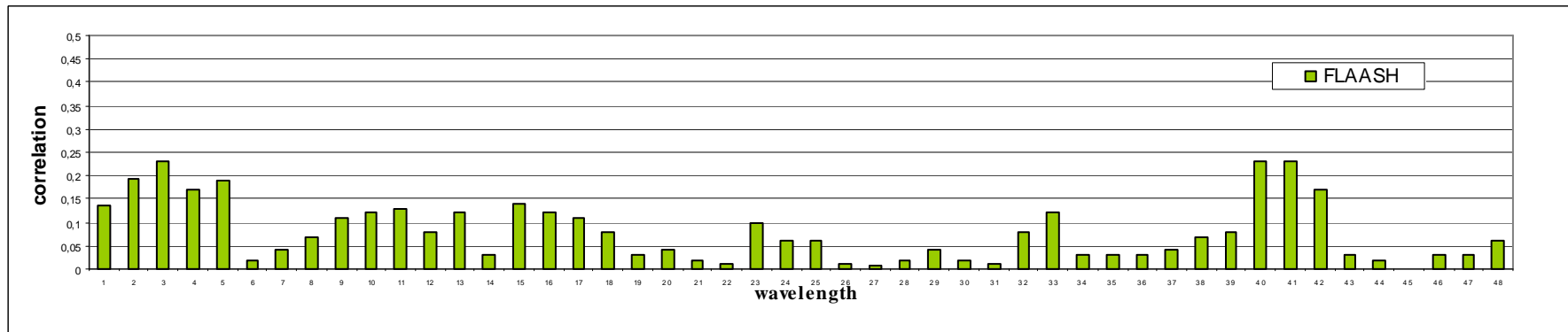
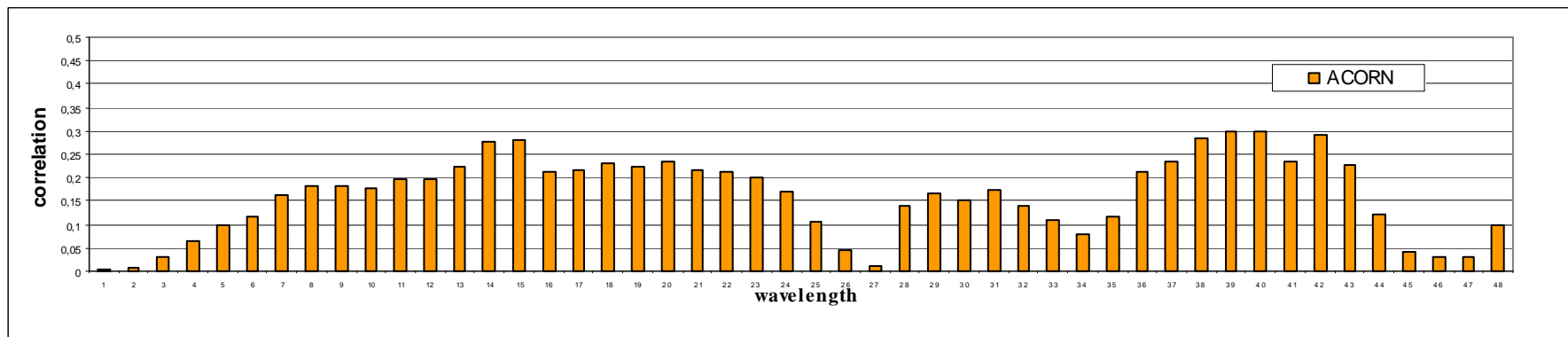
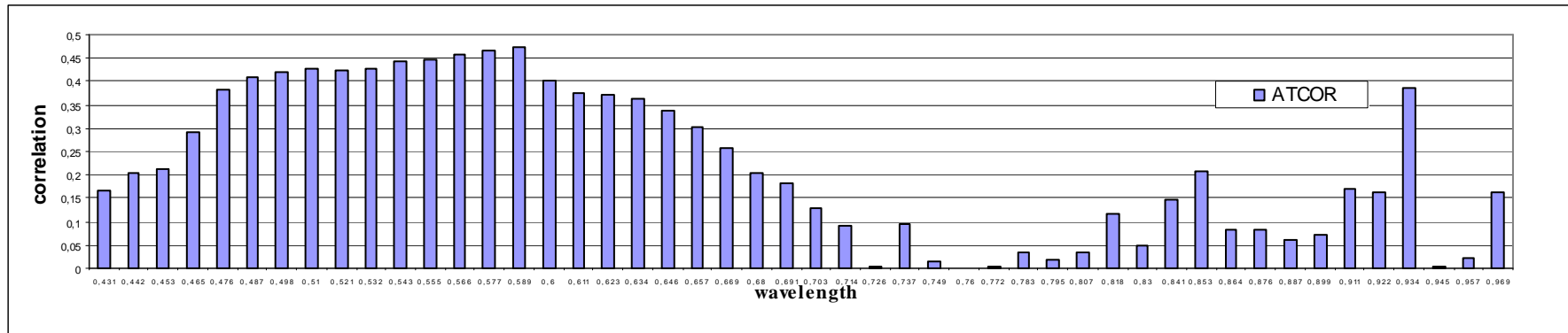

Corrected Image: CASI Flight lines displayed in RGB



Local averaging considering boat drifting (initial and final GPS)

St.	Time		Position In (m)		Position Out (m)		Distance (m)	Velocity (m/min)
	In	Out	E°	N°	E°	N°		
4	12h23	12h32	528900	5694740	528136	5694572	782	87
5	12h43	12h55	532116	5695004	531128	5694756	1018	85
8	13h08	13h16	535552	5695562	535084	5695524	469	59
10	13h31	13h42	538880	5697672	538260	5697516	639	58
11	13h51	14h03	537760	5699064	537508	5698840	373	28
12	14h13	14h23	535048	5702960	535036	5702492	470	47
13	14h36	14h46	531408	5706148	531892	5705532	783	78
14	15h01	15h09	528504	5711688	528504	5711196	492	61
9	15h36	15h48	538036	5696616	538192	5696356	303	25
7	15h55	16h06	534796	5697212	535208	5697212	232	21
6	16h14	16h26	531524	5696848	531792	5696724	295	21
3	16h34	16h43	528016	5695436	528248	5695316	261	29

Average spectra of each in situ station from CASI sensor

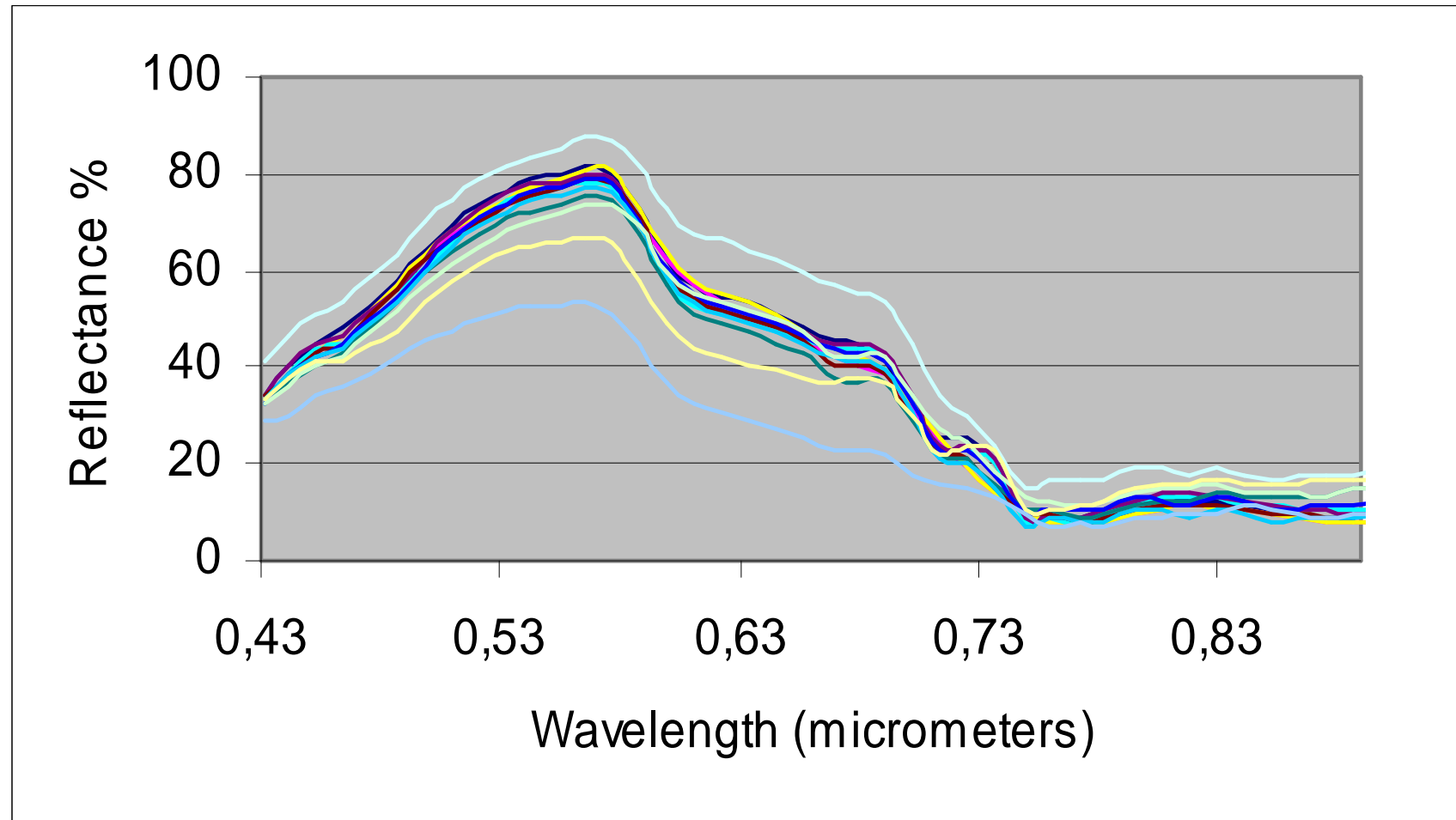

Research of correlations between spectral and in situ data

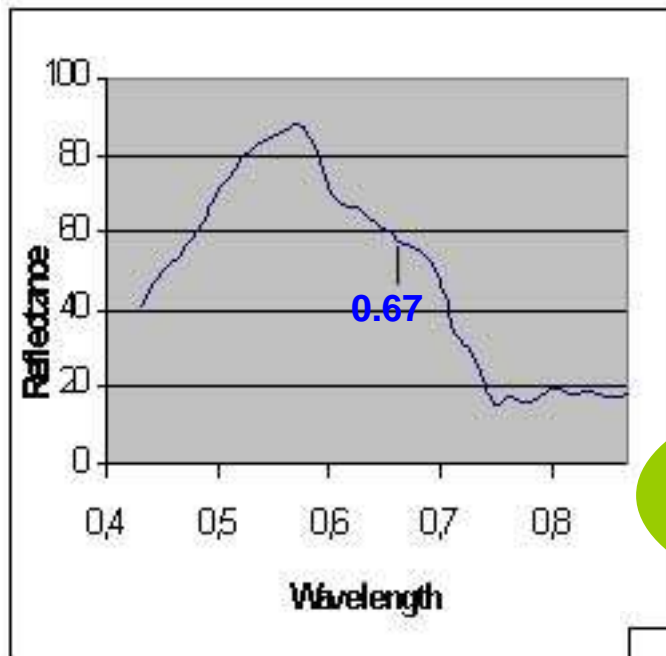

Difficulties of classical algorithms for
Case 2 waters

Chl a?

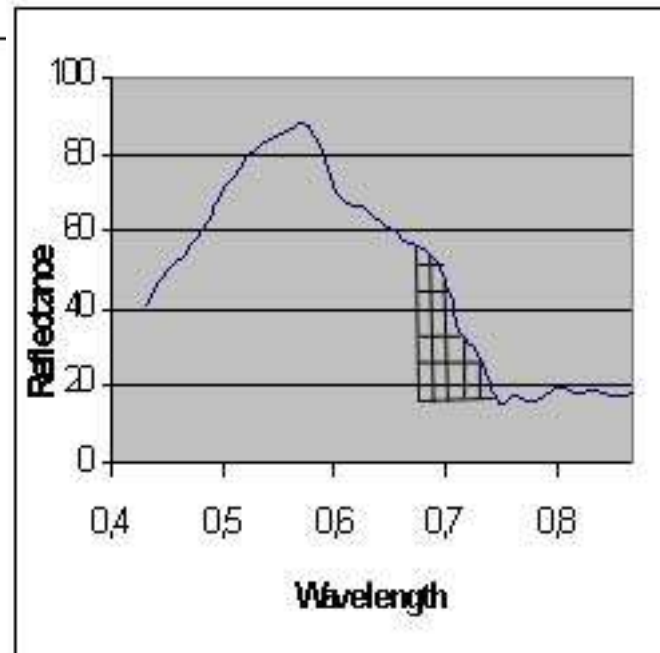
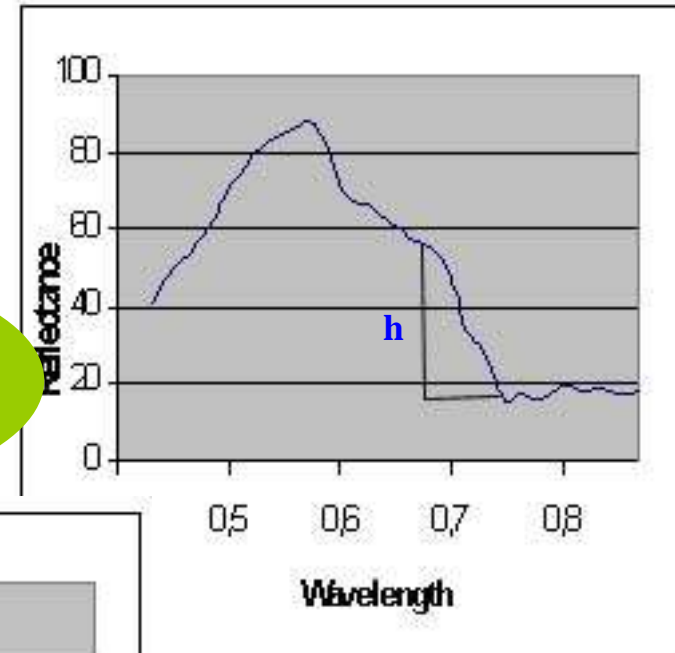

Absence of absorption pic around 0,67 micrometers

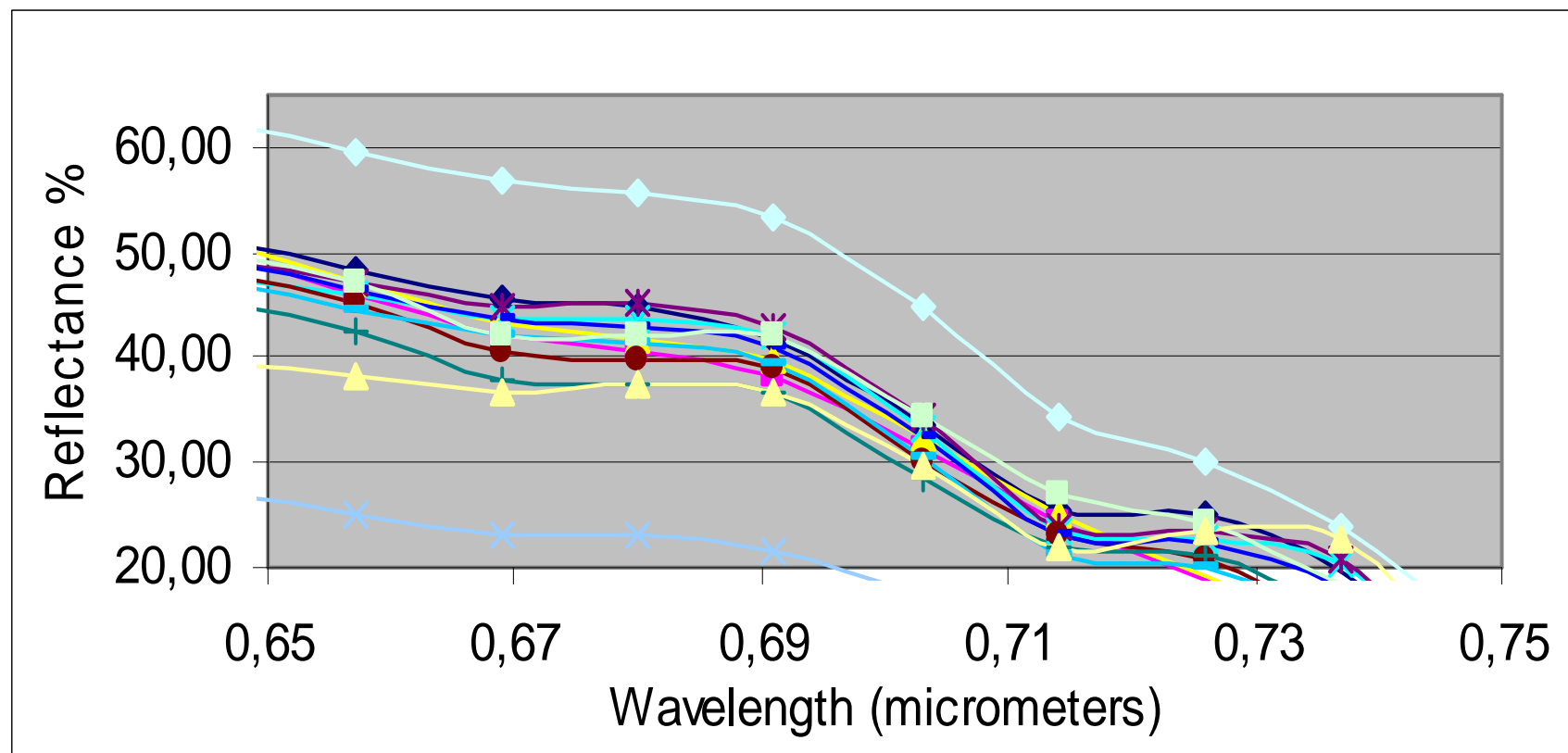

- **Broad and intense reflection by heavy loads of suspended matter**

Multiple Regressions

(Hirtle & Arencz, IJRS, 24-5, 953-967)

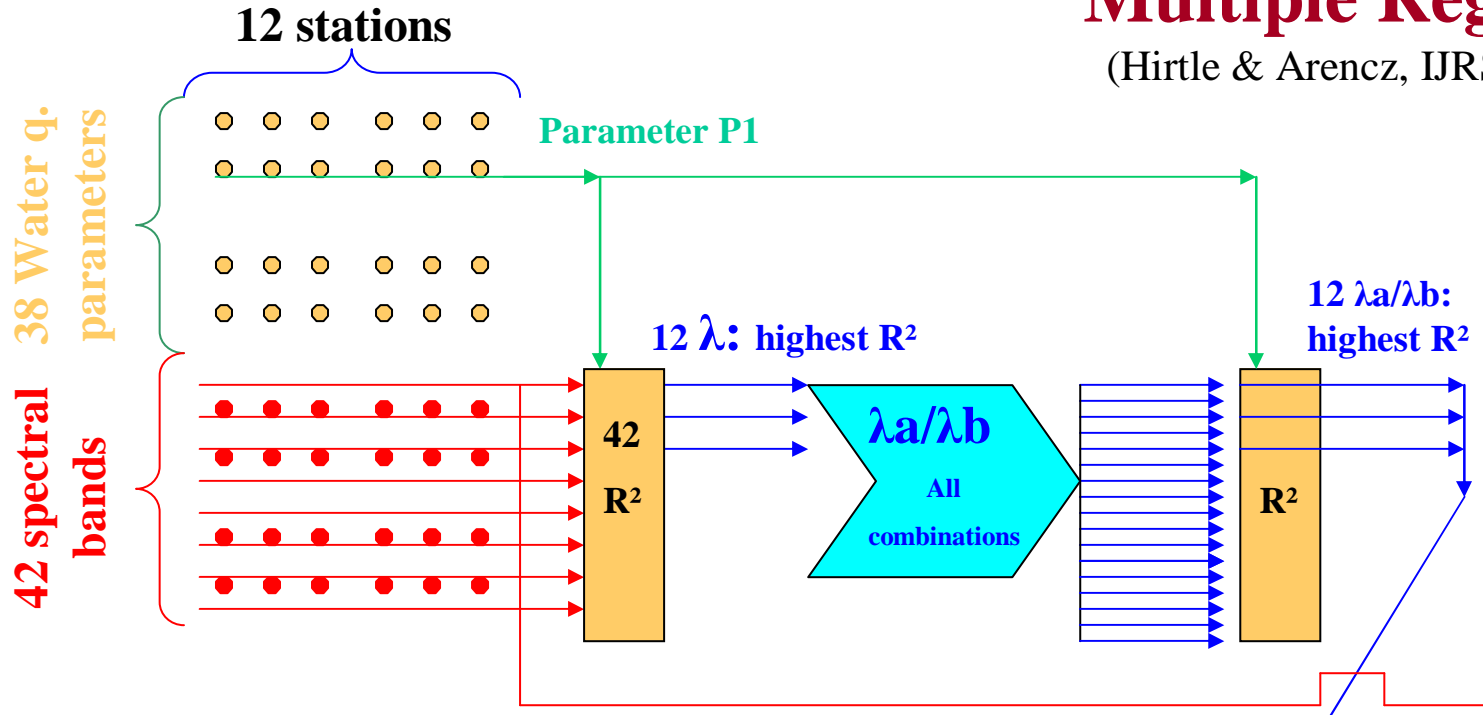

Multiple regressions between

P1 and all combinations of

- ratio 1 (any selected ratios)
- ratio 2 (ratio between **any spectral band** and the common denominator)

$$P1 = A \cdot \lambda a / \lambda b + B \cdot \lambda c / \lambda b + C$$

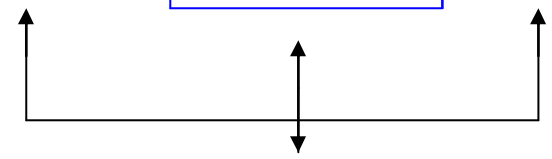

highest R²

Multiple regression results

	Parameter	Correlation coefficient (%)	image range	in situ range
1	Cryptophytes	96.91		
2	Dinoflagellates	96.61		
3	Diatoms (*10+6 ind.)	72.70	0.25 to 2 *	0.5 to 7.7
4	PCo₂ (ppm)	72.70	14 - 934	390 - 689
5	DIC (mmol/kg)	71.70	1.45 - 2.83	2.09 - 2.39
6	DOC (μmol)	76.6	16 - 188	114 - 176
7	CDOM (absorb 380 nm)	70.22	1.67 - 11.38	5 - 6.9
8	Chl a	48.21		
9	Chl c2	42.62		
10	Chl b	44.20		

* Range obtained from flight line 2

Colour Dissolved Organic Matter (CDOM)



$$CDOM = A + B \cdot \left(\frac{0.887}{0.521} \right) - C \left(\frac{0.510}{0.521} \right)$$

$R^2 = 70.3\%$

Absorbance 380 nm

m-1



Dissolved Organic Carbon (DOC)

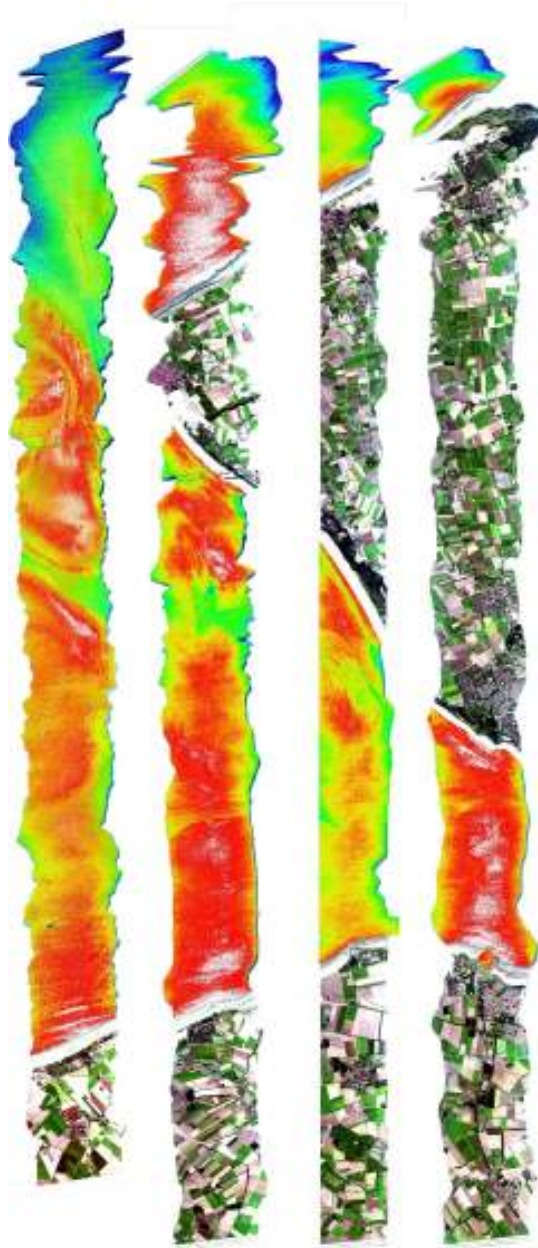

$$DOC = A + B \cdot \left(\frac{0.577}{0.566} \right) - C \left(\frac{0.510}{0.566} \right)$$

R² = 76.6%



Dissolved Inorganic Carbon (DIC)

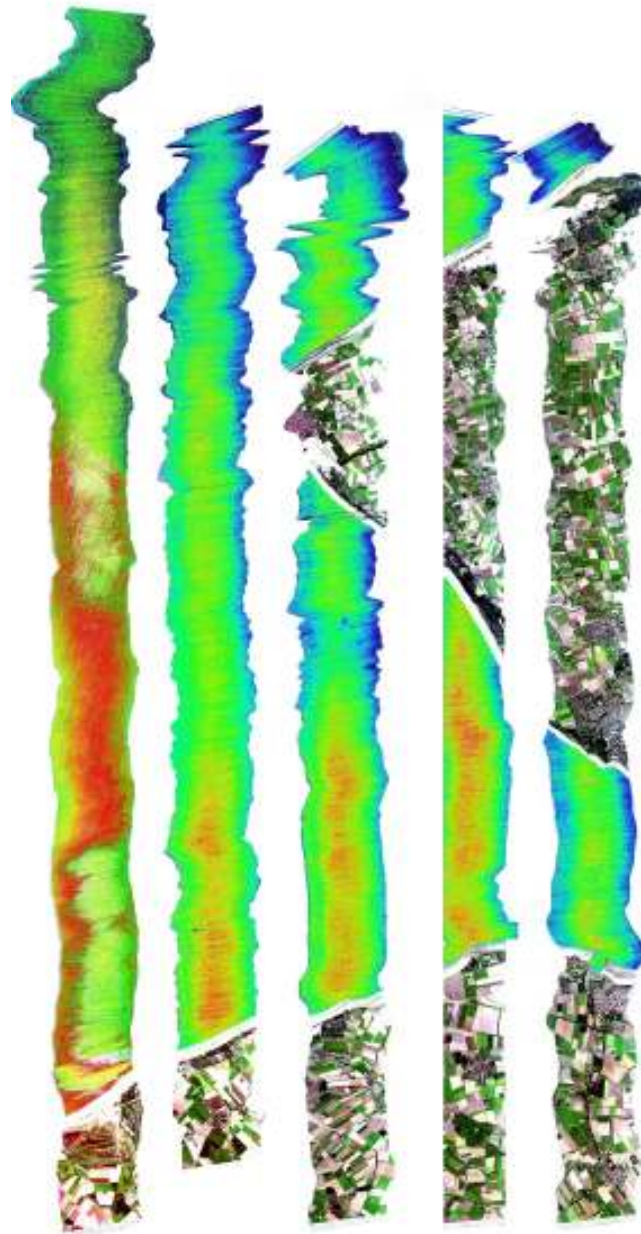

$$DIC = A + B \cdot \left(\frac{0.555}{0.657} \right) - C \left(\frac{0.498}{0.657} \right)$$

R² = 71.7%

Mmol/kg

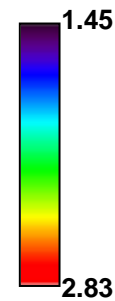

DIC

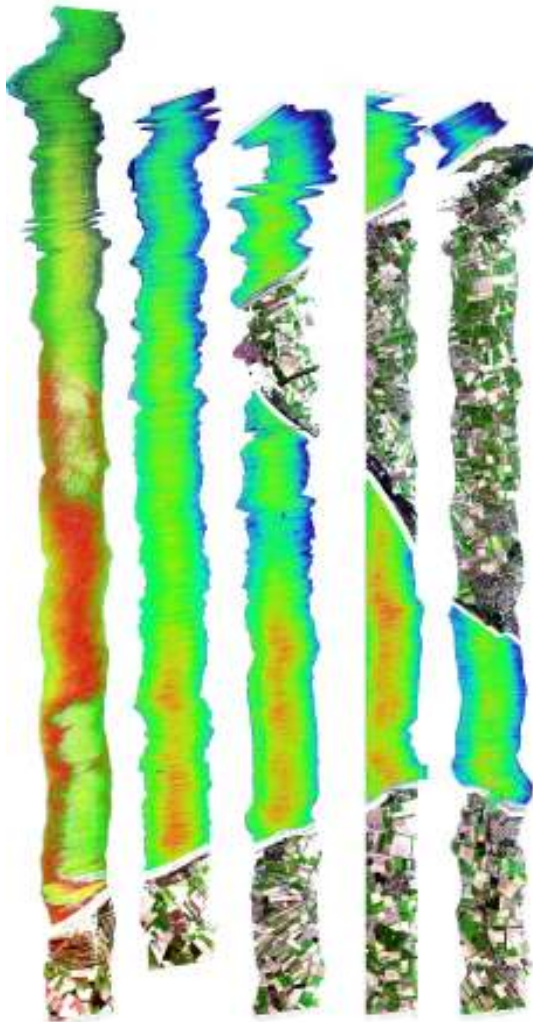

$$DIC = A + B \cdot \left(\frac{0.555}{0.657} \right) - C \left(\frac{0.498}{0.657} \right)$$

R² = 71,70 %



PCO₂

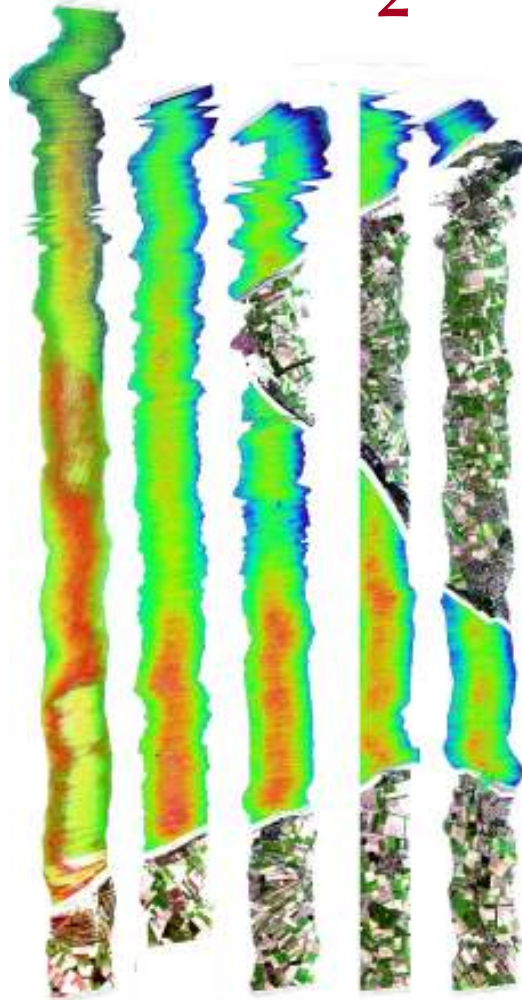

$$PCO_2 = A + B \cdot \left(\frac{0.543}{0.476} \right) - C \left(\frac{0.465}{0.476} \right)$$

R² = 72,70 %



Salinity

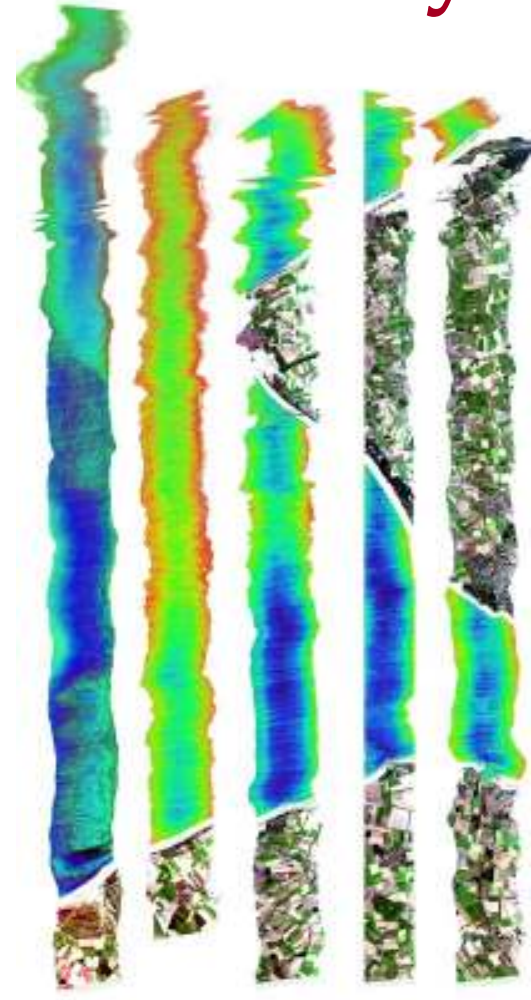

$$Salinity = A + B \cdot \left(\frac{0.543}{0.476} \right) - C \left(\frac{0.465}{0.476} \right)$$

R² = 72,40 %



pH



$$pH = A + B \cdot \left(\frac{0.589}{0.487} \right) - C \left(\frac{0.841}{0.487} \right)$$

R² = 75,00 %

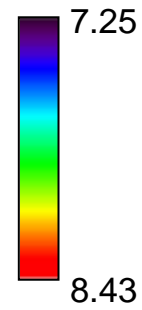

Across track Filtering

Principle (for each flight line):

Fit a 2nd degree polynomial on the average across track signal of each spectral band

Apply a constant filtering to remove this low frequency signal

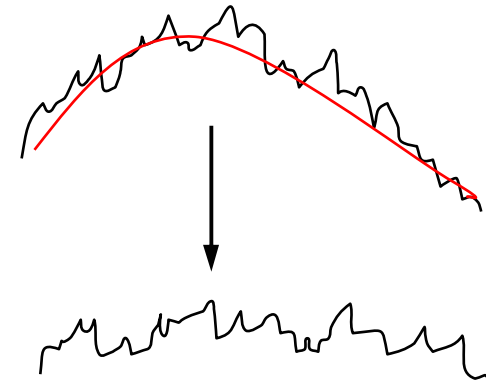

Correlation improvements:

	before filtering	after filtering	before filtering	after filtering
DIC	71.7	87.7	1.45 - 2.83	1.89 - 3.90
DOC	76.6	34.9	16 - 188	
Gilvin	70.3	77.7	1.67 - 11.38	3 - 14.43
pCO2	72.7	90.4	14 - 934	26 - 1900

Dissolved Inorganic Carbon (DIC)

$$DIC = A + B \cdot \left(\frac{0.841}{0.589} \right) - C \left(\frac{0.876}{0.589} \right)$$

$R^2 = 87,8\%$

Mmol/kg

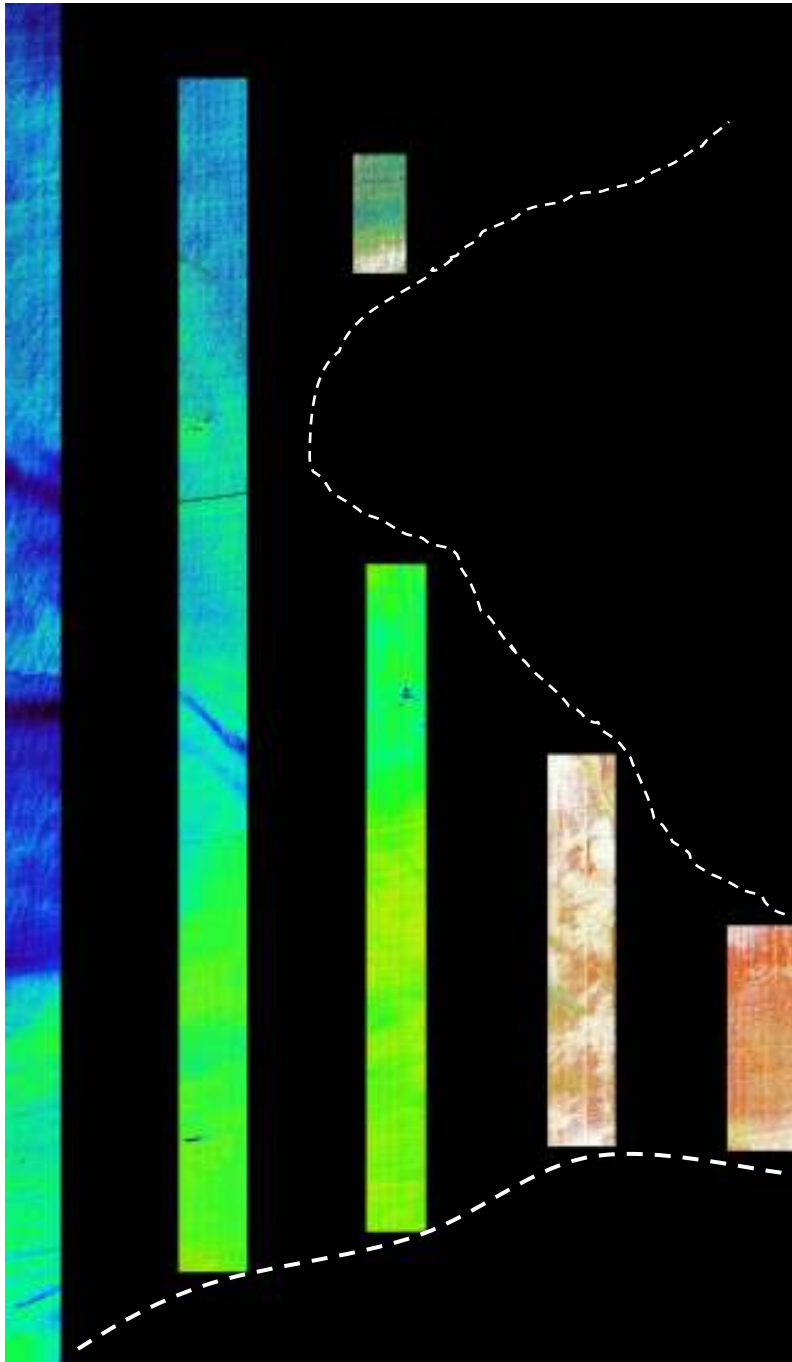
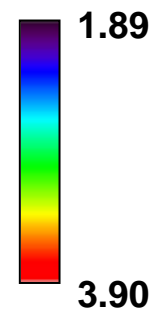

Correlations with First Derivative Spectrums

(Lahet et. al, IJRS, 2001, 22-9, 1639-1664)

Principle :

For each of the 38 parameters, run an automatic search for best correlation with the first derivative

$$(R\lambda_{(i+1)} - R\lambda_{(i)})/(\lambda_{(i+1)} - \lambda_{(i)})$$

Correlation improvements:

Salinity, Si, No3, Po4, Talk, pCO2, DIC:

R² ranging from 75% to 79,5 %, i.e. 3 to 6% higher then previously

All obtained with $\lambda_{(i)} = 464$ nm ; $\lambda_{(i+1)} = 475$ nm

CDOM: R² of 72,5 % (2,5% improvement), with $\lambda_{(i)} = 442$ nm ; $\lambda_{(i+1)} = 453$ nm

SPM: R² of 41,4% (or R= 64 % comparable with 60,7 % from Lahet, 2001, same approach, but higher number of stations, differenciation of water types, lower charge)

with $\lambda_{(i)} = 611,4$ nm ; $\lambda_{(i+1)} = 622,8$ nm

Correlations with First Derivative Spectrums

SPM:

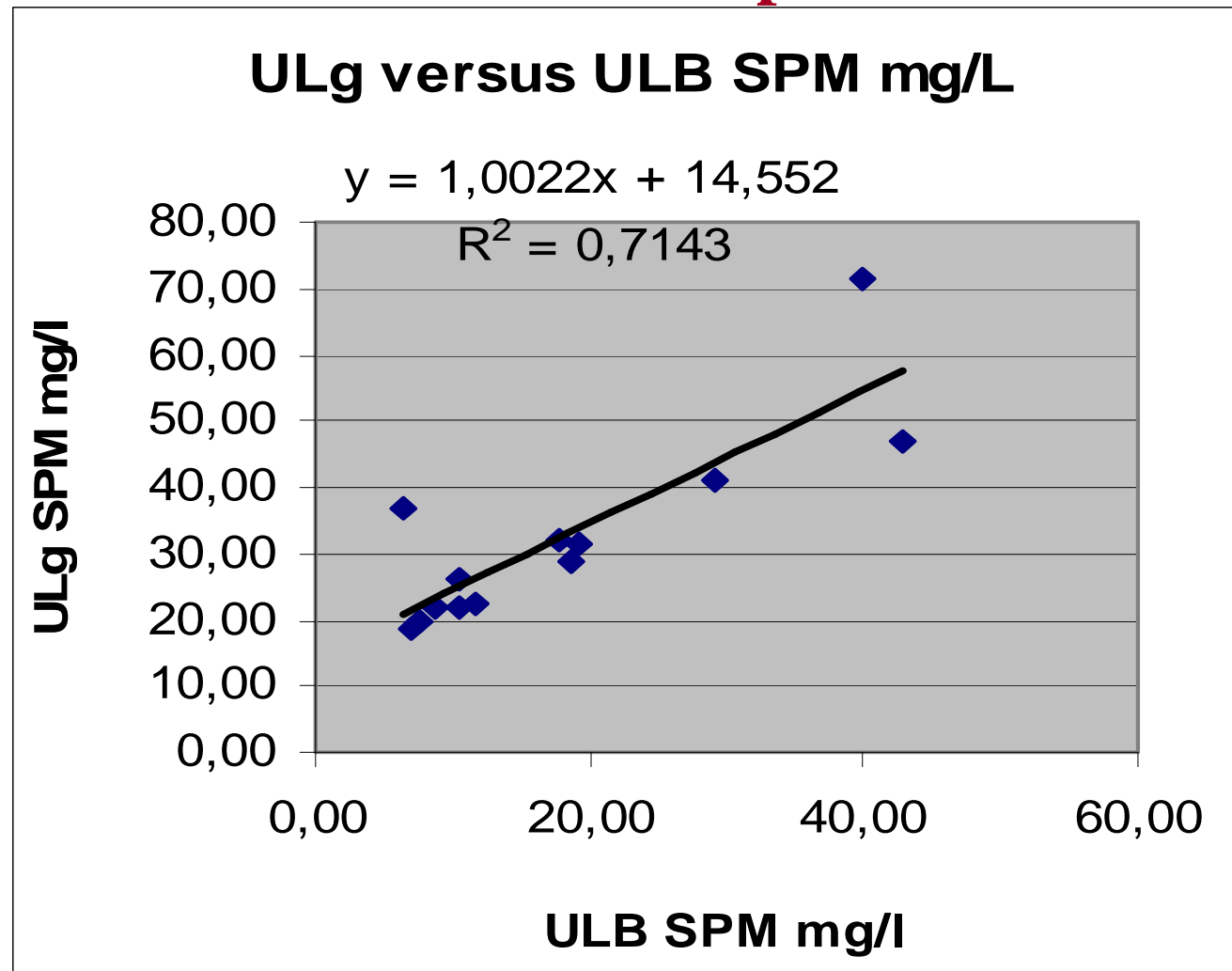

Ground « Truth » is also affected by errors (systematic and accidental, like for stations 4 and 14)

Back to Chlorophyll, Multiple Regressions

R² previously obtained: 48,21%

**Ratios: R634/R487 nm
 R498/R487 nm**

Without problematic samples 4 and 14: improvement to about 58%

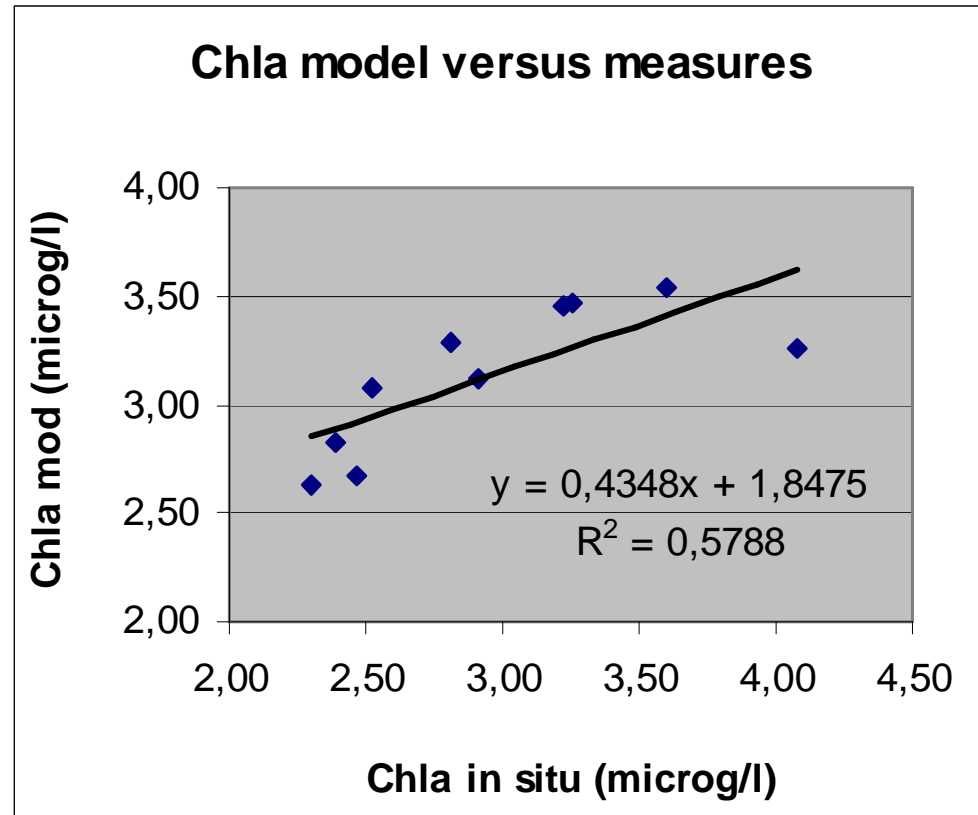

Station 13 out of the line...a confirmation of the necessity to split study according to water types (improvement to 87%) , or to non linear model?

Summary

CASI products

SWIR data were suffering important radiometric correction problems and could not be used

CASI Spectral bands could not be set as designed

CASI data recorded over water seems affected by

- a) “sun glim” and cross track systematic artefacts as revealed clearly by some parameter distribution (i.e. DIC)
- b) Bathymetry effects (i.e. DOC)

First attempt to remove artefacts were realised with cross-track filtering.

- ⇒ Improvement of across track correction method (various parameters to be adapted, artefact of geometrical or radiometrical correction?)
- ⇒ Localisation of zones of extremes values (out of range values) for each parameter, comparison and masking (such as in first flight line, consequently to intense direct sun reflection on water surface, and to the presence of very shallow sand banks probably responsible for extreme values in some ranges)

Summary

Algorithms and prediction of biogeochemical parameters

Ratio Multiple Regression and well as First Derivative approach proved very convenient for first statistical exploration of large hyperspectral databases

Some results obtained are very encouraging in terms of R^2 , range, distribution (i.e. CDOM)

In case of limited number of ground truth stations, attention must be paid to the general distribution range and pattern established in order to avoid inconsistent correlations



Developing specific algorithms by splitting database according to general water types



Combining previous empirical approach with (a) physical models, including fine bathymetry effect and (b) classical hyperspectral algorithms making use of known isolated spectral signatures (from literature and laboratory spectral measurements on water samples)

Summary

Constraints of the marine environment

At sea, “Ground truth” may be difficult to define, and requires much time and resources.

- ⇒ Time delay between in situ and flight should be reduced (using several smaller boats), as it is a very dynamic scene.
- ⇒ Ground truth must be more important and reliable in order to allow some validation and accuracy assessment. Enlarging database should be done through (a) increased number of in situ stations; (b) data exchange with other campaigns realised in the same period (TNO netherlands CASI campaign; Mumm, V. de Cauwer). Larger databases would
- ⇒ Hydrodynamic simulation of the water displacement during field campaign may allow to reduce artefacts due to non synoptic measures.